

Extract from our online catalogue:

Ics+340/DD

Current to: 2024-03-01

NEW
DESIGN



The new lcs+ ultrasonic sensors come in a very compact square-shaped housing - with analogue or switching output + IO-Link.

HIGHLIGHTS

- › Very compact housing dimensions › only 62 mm x 62 mm x › 37.2 › mm
- › IO-Link interface › for support of the new industry standard
- › Synchronisation and multiplex mode › for simultaneous operation of up to ten sensors in close quarters
- › 8 m maximum detection range
- › UL Listed to Canadian and US safety standards
- › Smart Sensor Profiles › more transparency between IO-Link Devices

BASICS

- › 1 Push-Pull switching output, or 2 pnp switching outputs
- › Analogue output 4–20 mA and 0–10 V › with automatic switching between current and voltage outputs
- › microsonic Teach-in by using button T1 and T2
- › 0.18 mm to 2.4 mm resolution
- › Temperature compensation
- › 9–30 V operating voltage
- › LinkControl › for configuration of sensors from a PC

Description

The lcs+ ultrasonic sensors

have a block-like plastic housing with a base area of only 62 x 62 mm and four fastening bores.

The sensors are Listed to applicable UL Standards and requirements by UL for Canada and the US.

Two dual colour LEDs

show all operating statuses.

Three output stages are available for selection:



1 Push-Pull switching output with pnp or npn switching technology



2 pnp switching outputs



1 analogue output 4–20 mA or 0–10 V

Using the two Teach-in buttons T1 and T2

the lcs+ sensors can be easily set.

The lcs+ sensors with switching output have three operating modes:

- › Single switching point
- › Two-way reflective barrier
- › Window mode

Teach-in of a single switching point

- › Place object to be detected (1) at the desired distance
- › Push button T2 for about 3 seconds
- › Then push button T2 again for about 1 second

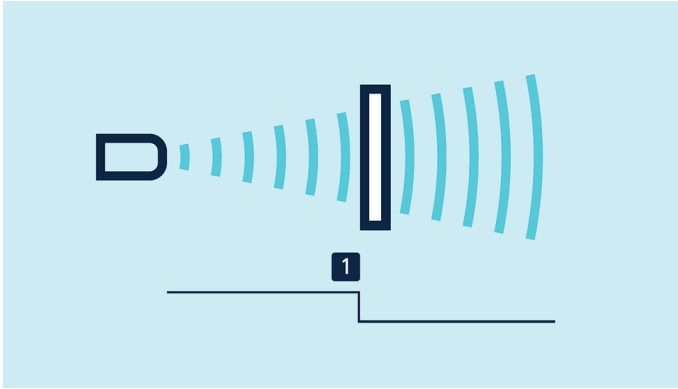

Teach-in of a switching point

Teach-in of a two-way reflective barrier

with a fixed mounted reflector

- › Push button T1 for about 3 seconds
- › Then push button T1 again for about 10 seconds

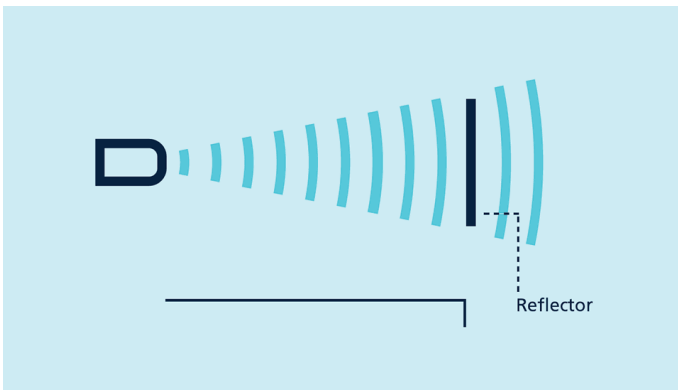

Teach-in of a two-way reflective barrier

For setting the analogue output

- › Initially position the object to be detected to the sensor-close window limit (1)
- › Push button T1 for about 3 seconds
- › Then move the object to the sensor-distant window limit (2)
- › Then push button T1 again for about 1 second

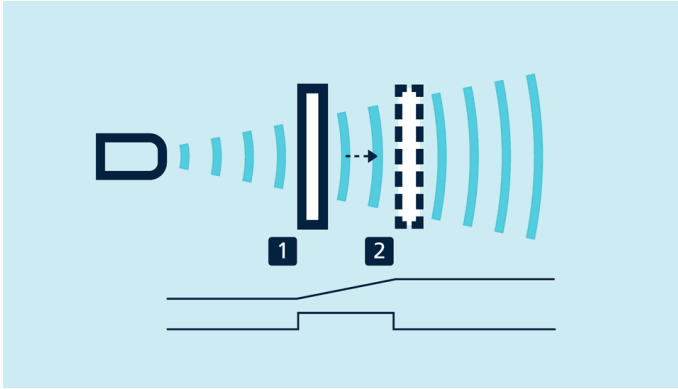

Teach-in of an analogue characteristic or a window with two switching points

For configuration of a window

with two switching points on a single switched output, the procedure is the same as setting the analogue.

Analogue sensors

check the connected working resistance at the output and automatically switch to 4–20 mA current output or 0–10 V voltage output.

NCC/NOC

and rising/falling analogue characteristics can also be set via the buttons.

LinkControl

permits comprehensive parameterisation of lcs+ ultrasonic sensors via the **LinkControl adapter** LCA-2 which connects the sensors to the PC.



Sensor connected to the PC via LCA-2 for programming

Easy to synchronise

If several lcs+ ultrasonic sensors are operated in one application, they can be synchronised via pin 5 to prevent.

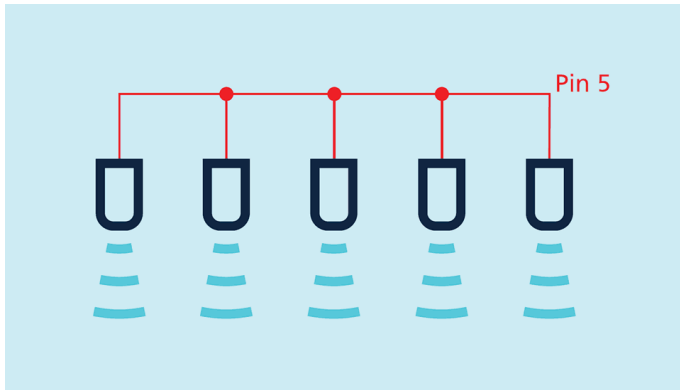

Synchronisation using pin 5

If more than 10 sensors must be synchronised, this can be carried out with the **SyncBox1** , which is available as an accessory. Synchronisation via pin 5 is also possible in IO-Link mode.

IO-Link

Ultrasonic sensors **lcs+340/F/A** and **lcs+600/F/A** have a Push-Pull switching output and support IO-Link in version 1.1 as well as the Smart Sensor profile.

lcs+340/DD

scale drawing

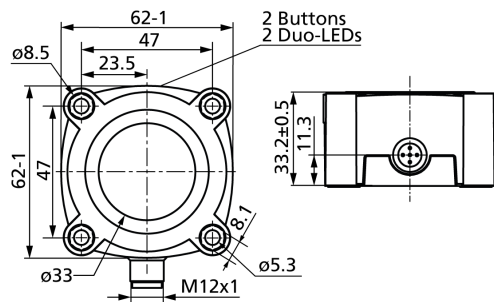

detection zone

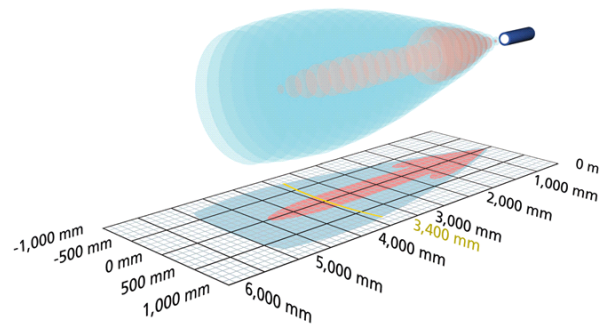

2 x pnp



5,000 mm

measuring range	350 - 5.000 mm
design	cuboidal
operating mode	proximity switch/reflective mode reflective barrier window mode
particularities	UL Listed

ultrasonic-specific

means of measurement	echo propagation time measurement
transducer frequency	120 kHz
blind zone	350 mm
operating range	3,400 mm
maximum range	5,000 mm
resolution	0.18 mm
reproducibility	± 0.15 %
accuracy	± 1 % (temperature drift internally compensated)

electrical data

operating voltage U_B	9 - 30 V d.c., reverse polarity protection
voltage ripple	± 10 %
no-load current consumption	≤ 60 mA

lcs+340/DD

outputs

output 1	switching output pnp: $I_{\max} = 200 \text{ mA}$ ($U_B = 2V$) NOC/NCC adjustable, short-circuit-proof
output 2	switching output pnp: $I_{\max} = 200 \text{ mA}$ ($U_B = 2V$) NOC/NCC adjustable, short-circuit-proof
switching hysteresis	50 mm
switching frequency	4 Hz
response time	172 ms
delay prior to availability	< 380 ms

inputs

input 1	com input synchronisation input
---------	------------------------------------

housing

material	PBT
ultrasonic transducer	polyurethane foam, epoxy resin with glass contents
class of protection to EN 60529	IP 67
operating temperature	-25°C to +70°C
storage temperature	-40°C to +85°C
weight	180 g

technical features/characteristics

temperature compensation	yes
controls	2 push-buttons
scope for settings	Teach-in via push-button LCA-2 with LinkControl
Synchronisation	yes
multiplex	yes
indicators	2 x three-colour LED
particularities	UL Listed

Ics+340/DD

pin assignment

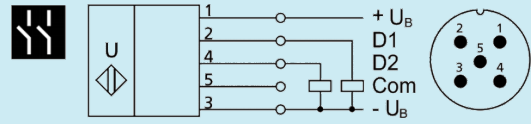

order no.

Ics+340/DD

The content of this document is subject to technical changes.
Specifications in this document are presented in a descriptive way
only. They do not warrant any product features.