

Vacuum generators OVEM

FESTO



Vacuum generators OVEM

Key features

At a glance

Rapid purging of vacuum for safe placement of the workpiece by means of an integrated solenoid valve for controlling the ejector pulse

Central electrical connection via an M12 plug

OVEM-...-1PD/2P/2N/PU/PI/LK

Monitoring and visualisation of the vacuum pressure by means of a vacuum sensor with LCD display (bar)

OVEM-...-LK

Vacuum sensor with IO-Link

Adjustment of the ejector pulse via a flow control screw

Prevention of contamination of the vacuum generator by means of an integrated filter

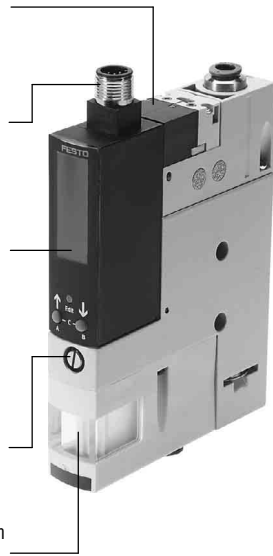

Quick and secure installation thanks to QS fitting

Fast vacuum build-up by means of an integrated solenoid valve for controlling the compressed air supply

OVEM-...-1P/1N

Monitoring of the vacuum pressure and status displays for switching output and solenoid valves by means of a vacuum sensor with LED display

Prevention of pressure drops by means of an integrated check valve

Maintenance-free operation and reduced noise level through an integrated, open silencer

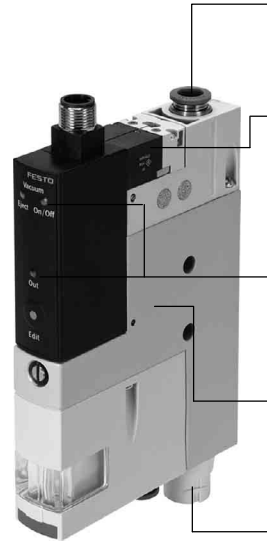

The modular vacuum generator series

The modular vacuum generator series OVEM offers a wide range of individually selectable functions, making it possible to find a solution for the most varied of applications.

Functions	Values
Laval nozzle	0.45 mm
	0.7 mm
	0.95 mm
	1.4 mm
	2.0 mm ¹⁾
Vacuum generator characteristics	High vacuum
	High suction rate
Housing size	20 mm, metric version, display in bar
	20 mm, NPT version, display in inchHg ²⁾
Pneumatic connections	QS fittings, with or without open silencer
	QS fittings (inch), with or without open silencer ²⁾
	G female thread, with or without open silencer
	NPT female thread, with or without open silencer ²⁾
	Prepared for supply manifold
Normal position of the vacuum generator	Normally open, with or without ejector pulse
	Normally closed, with or without ejector pulse
Electrical connection	Plug M12 (5-pin)
Vacuum sensor	Without vacuum sensor
	1 switching output PNP or NPN, LED display
	1 switching output PNP, LCD display
	2 switching outputs PNP or NPN, LCD display
	1 switching output PNP and 1 analogue output, LCD display
IO-Link, LCD display	
Alternative vacuum display	InchHg ³⁾
	InchH2O ^{2) 3)}
	Bar ^{2) 3)}

1) Restricted choice of functions
 2) Product documentation → Internet: ovem-npt
 3) Vacuum sensor with LCD display

Vacuum generators OVEM

Key features

The innovative vacuum generator			
Economical		Easy to use	
<ul style="list-style-type: none"> Short switching times thanks to integrated solenoid valves <ul style="list-style-type: none"> Vacuum on/off Ejector pulse Quick, precise and safe placement of the workpiece by means of the ejector pulse Cost saving through preventive maintenance/service thanks to maintenance indicator 	<ul style="list-style-type: none"> Cost saving through integrated air-saving function Powerful supply of multiple vacuum generators via a common supply manifold (→ page 19) Low-cost variants with one switching output (OVEM-...-1P/1N) 	<ul style="list-style-type: none"> Simple installation via M12 plugs and QS fittings Simple mounting via screws All control elements are on one side Quiet operation thanks to integrated silencers 	<ul style="list-style-type: none"> Vacuum sensor with LCD display (OVEM-...-1PD/2P/2N/PU/PI/LK) <ul style="list-style-type: none"> Vacuum is displayed numerically and as a bar chart Important parameters and diagnostic information are displayed
Reliable	Space-optimised	Easy to maintain	Choice of mounting types
<ul style="list-style-type: none"> Permanent monitoring of the entire vacuum system via a vacuum sensor to reduce downtimes (condition monitoring) Prevention of pressure drop by means of an integrated air-saving function in conjunction with an integrated check valve 	<p>All functions are compactly integrated in one unit.</p> <ul style="list-style-type: none"> No protruding elements such as valves or vacuum sensor Space-optimised installation is possible as all the control elements can be accessed from one side 	<ul style="list-style-type: none"> Integrated filter with inspection window for maintenance indication Reduced contamination of the vacuum generator thanks to an open silencer 	<ul style="list-style-type: none"> Direct mounting or via mounting bracket Straightforward mounting on H-rail via accessories Interlocking of multiple vacuum generators on a common supply manifold (→ page 19)
Operating principle of OVEM			
Vacuum on/off		Vacuum sensor	Ejector pulse
<p>The compressed air supply is controlled by an integrated solenoid valve. The solenoid valve can be supplied with two different switching functions, NC and NO.</p> <ul style="list-style-type: none"> NC - normally closed: The vacuum is generated when the vacuum generator is pressurised with compressed air and the solenoid valve has been switched. 	<ul style="list-style-type: none"> NO - normally open: The vacuum is generated when the vacuum generator is pressurised with compressed air and the solenoid valve is in the normal position. 	<p>The set or taught-in reference value for the generated vacuum is monitored via an integrated vacuum sensor. If the reference value is reached or if it is not reached due to malfunctions (e.g. leakages, dropped workpiece), the vacuum sensor emits an electrical signal.</p>	<p>After the vacuum is switched off, an ejector pulse is activated and generated by means of a second integrated solenoid valve to release the workpiece safely from the suction cup and to purge the vacuum quickly.</p>
Connection to higher-level systems and configuration of the switching outputs			
OVEM-...-1P/1PD/1N	OVEM-...-2P/2N/PU/PI		OVEM-...-LK
<ul style="list-style-type: none"> Switching inputs for actuating the solenoid valves for vacuum generation and ejector pulse OVEM-...-1P/1N only: one switching output for supplying a control signal <ul style="list-style-type: none"> Configured as an N/O contact Switching function configured as a threshold value comparator OVEM-...-1PD only: one digital switching output for supplying a control signal <ul style="list-style-type: none"> Switching output can be configured as N/C or N/O contacts Switching function of the output can be configured as a threshold value or window comparator 	<ul style="list-style-type: none"> One digital switching input for actuating the solenoid valves Two digital switching outputs or one digital switching output and one analogue output for supplying control signals <ul style="list-style-type: none"> Switching outputs can be configured as N/C or N/O contacts Switching function of the outputs can be configured as a threshold value or window comparator 	<ul style="list-style-type: none"> If there are two switching outputs, these can be configured independently of each other. This enables tasks to be performed in parallel with one vacuum generator, reducing the time needed for sorting good and reject parts, for example. 	<ul style="list-style-type: none"> Digital setpoint and actual value transfer for simple parameterisation and diagnostic feedback. Communication takes place in IO-Link mode with an IO-Link master. SIO mode is supported. In the case of this local configuration using the operating buttons on the vacuum sensor, the OVEM takes on the function of an OVEM-...-2P.

Vacuum generators OVEM

Key features

OVEM...-1PD/2P/2N/PU/PI/LK – Air-saving function LS (-CE, -OE)

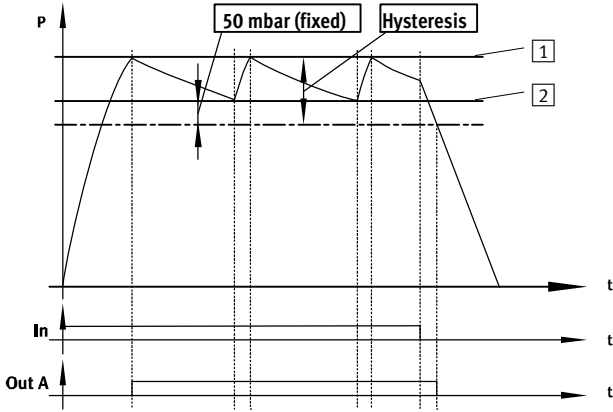

If the desired threshold value **1** for the vacuum is reached, vacuum generation is automatically switched off. A check valve prevents a decrease of the vacuum.

Nonetheless, leakage (e.g. due to rough workpiece surfaces) will slowly

reduce the vacuum. If the vacuum drops below the threshold value **2**, vacuum generation is switched on automatically. Vacuum is generated until the set threshold value **1** is reached again.

OVEM...-1PD/2P/2N/PU/PI/LK – Condition monitoring and diagnostics

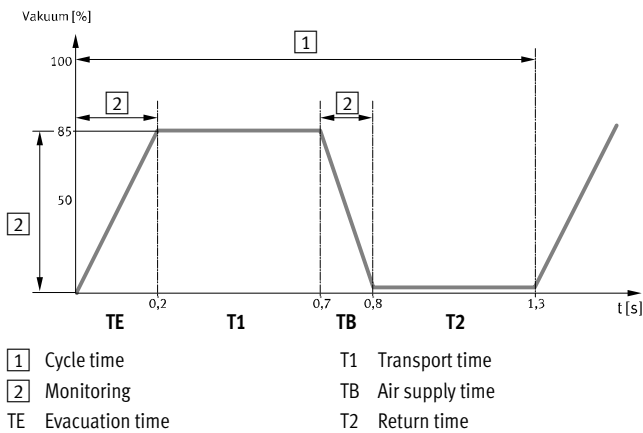

- 1** Cycle time
- 2** Monitoring
- TE Evacuation time
- T1 Transport time
- TB Air supply time
- T2 Return time

The main operating parameters

- Vacuum
 - Evacuation time
 - Air supply time
- are continuously measured in the vacuum generator and compared with the individually set reference values (condition monitoring). If deviations in the reference values occur, these will be determined by the vacuum generator and shown on the display (diagnostics).

In addition, in the case of an OVEM with two switching outputs (-2P, -2N, -LK in SIO mode) diagnostic messages can also be transmitted by the switching output Out B.

This permits preventative action

- in order to prevent machine failure or downtime, for example, through timely maintenance
- and to ensure process reliability (adherence to the cycle time).

OVEM...-1P/1N – From the teach-in point to the switching point

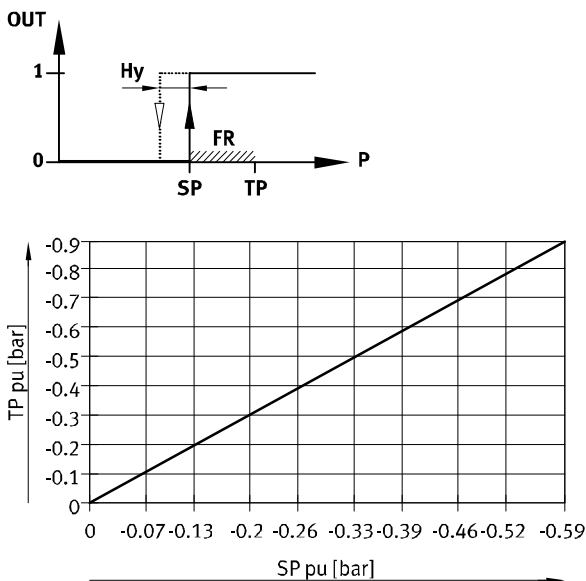

The switching point is determined from the teach pressure and the functional reserve. A function reserve (35% of the teach pressure) is deducted from the teach pressure ($SP = TP - 0.35 \cdot TP$).

For example, with a teach pressure of -0.5 bar, a switching point of -0.33 bar is set.

The hysteresis has a fixed value.

- TP Teach-in point
- SP Switching point
- Hy Hysteresis
- FR Functional reserve

Vacuum generators OVEM

Peripherals overview

FESTO

OVEM-...-QS/QO/GN/GO-...

OVEM-...-PL/PO-...¹⁾

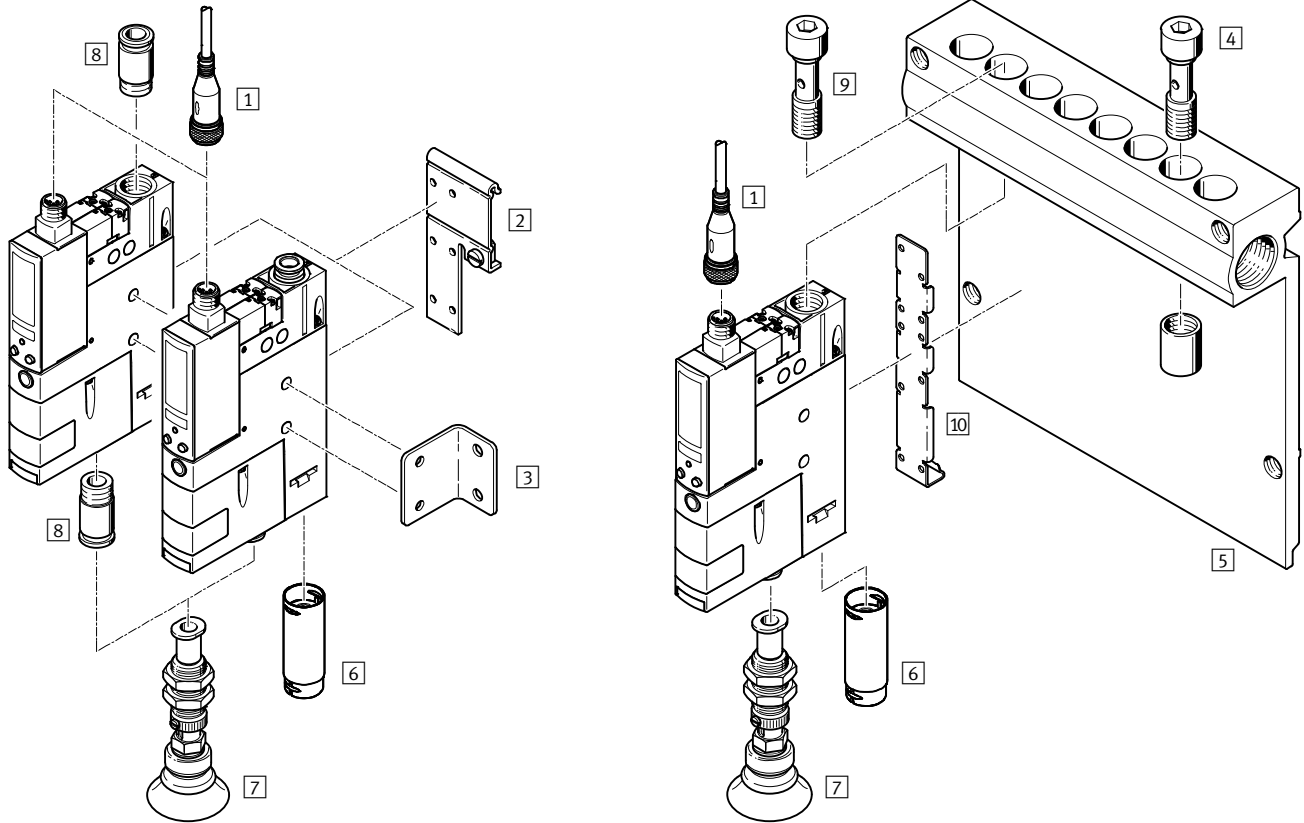

1) Hollow bolt ⁹ and mounting bracket ¹⁰ are included in the scope of delivery of the OVEM-...-PL/PO-...

Mounting components and accessories		OVEM-...-QS/QO/GN/GO-...				OVEM-...-PL/PO-...		→ Page/Internet
		QS	QO	GN	GO	PL	PO	
¹	Connecting cable NEBU-M12		■			■	21	
²	H-rail mounting OABM-H		■			-	20	
³	Mounting bracket HRM-1		■			-	21	
⁴	Blanking plug OASC-G1-P		-			■	20	
⁵	Common supply OABM-P...		-			■	19	
⁶	Silencer extension UOMS-1/4	-	■ ²⁾	-	■ ²⁾	-	■ ²⁾	21
⁷	Suction grippers ESG		■			■	esg	
⁸	Push-in fitting QS	-		■		-	qs	
-	Suction cup holder ESH		■			■	esh	
-	Suction cups with connection attachments ESS		■			■	ess	

2) Silencer extension UOMS-1/4 ⁶ is included in the scope of delivery of the OVEM-20.

Vacuum generators OVEM

Type codes

OVEM - 10 - H - B - QO - CE - N - 2P -

Type	
OVEM	Vacuum generator

Nominal size of laval nozzle [mm]	
05	0.45
07	0.7
10	0.95
14	1.4
20	2.0

Ejector characteristic	
H	High vacuum
L	High suction rate

Housing width	
B	Grid dimension 20 mm

Pneumatic connections	
QS	P-V-R with QS fitting
QO	P-V with QS fitting, R with open silencer
GN	P-V-R with female thread
GO	P-V with female thread, R with open silencer
PL	Common supply manifold prepared, V-R with QS fitting
PO	Prepared for common supply manifold, V with QS fitting, R with open silencer

Normal position of the vacuum generator	
ON	NO, normally open (vacuum generation)
OE	NO, normally open (vacuum generation) with ejector pulse
CN	NC, normally closed (no vacuum generation)
CE	NC, normally closed (no vacuum generation) with ejector pulse

Electrical connection	
N	Plug M12 (5-pin)

Vacuum sensor	
-	Without vacuum sensor
1P	1 switching output PNP
1PD	1 switching output PNP and LCD display
1N	1 switching output NPN
2P	2 switching outputs PNP
2N	2 switching outputs NPN
PU	1 switching output PNP, 1 analogue output 0 ... 10 V
PI	1 switching output PNP, 1 analogue output 4 ... 20 mA
LK	IO-Link

Vacuum display	
-	Bar
H	InchHg

Vacuum generators OVEM

Technical data

Function

NC, normally closed:

- Ejector pulse
- QS fitting or G female thread
- With open silencer
- Prepared for common supply manifold

Temperature range
0 ... +50 °C

Operating pressure
2 ... 8 bar

www.festo.com

NO, normally open:

- Ejector pulse
- QS fitting or G female thread
- With open silencer
- Prepared for common supply manifold

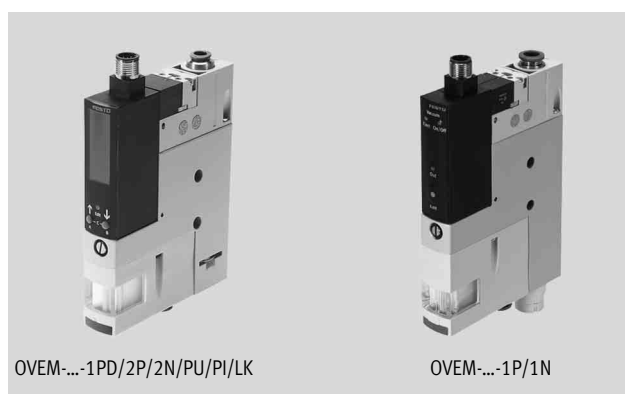

General technical data		OVEM-05	OVEM-07	OVEM-10	OVEM-14	OVEM-20
Type						
Nominal width of laval nozzle	[mm]	0.45	0.7	0.95	1.4	2.0
Grid dimension	[mm]	20				
Grade of filtration	[µm]	40				
Mounting position		Any				
Type of mounting		With through-hole With female thread Via accessories				
Pneumatic connection 1 (P)		➔ Dimensions on page 13				
Vacuum port (V)		➔ Dimensions on page 13				
Pneumatic connection 3 (R)		➔ Dimensions on page 13				

Technical data – Design		OVEM-05/07/10/14/20-...-QO/GO/PO	OVEM-05/07/10/14/20-...-QS/GN/PL
Design		Modular	
Ejector characteristic		High vacuum/standard H High suction rate/standard L	
Silencer design		Open	–
Integrated function	ON/CN	Electric on-off valve	Electric on-off valve
		Vacuum sensor ¹⁾	Vacuum sensor ¹⁾
		Filter	Filter
		Open silencer	–
	OE/CE	Electric on-off valve	Electric on-off valve
		Ejector pulse, electrical	Ejector pulse, electrical
		Flow control	Flow control
		Vacuum sensor ¹⁾	Vacuum sensor ¹⁾
		Air saving function, electrical ²⁾	Air saving function, electrical ²⁾
		Check valve	Check valve
Valve function	ON/OE	Open	
	CN/CE	Closed	
Manual override		Non-detenting	
		Additionally via control buttons ²⁾	

1) Only for OVEM-...-1P/1PD/1N/2P/2N/PU/PI/LK

2) Only possible for OVEM-...-1PD/2P/2N/PU/PI/LK

Vacuum generators OVEM

Technical data

Operating and environmental conditions		
Type	OVEM-05/07/10/14/20-...-QO/GO/PO	OVEM-05/07/10/14/20-...-QS/GN/PL
Operating pressure [bar]	2 ... 8	2 ... 6
Nominal operating pressure [bar]	6	
Operating medium	Compressed air to ISO 8573-1:2010 [7:4:4]	
Note on operating/pilot medium	Lubricated operation not possible	
Ambient temperature [°C]	0 ... +50	
Temperature of medium [°C]	0 ... +50	
Relative humidity [%]	5 ... 85	
Protection class	III	
Degree of protection	IP65	
Corrosion resistance class CRC ¹⁾	2	
CE marking (see declaration of atmosphere)	To EU EMC Directive ²⁾	
Approval certificate	c UL us listed (OL)	
	RCM Mark	
KC marking	KC EMC	

- Corrosion resistance class CRC 2 to Festo standard FN 940070
Moderate corrosion stress. Indoor applications in which condensation may occur. External visible parts with primarily decorative requirements for the surface and which are in direct contact with the ambient atmosphere typical for industrial applications.
- For information about the applicability of the component see the manufacturer's EC declaration of conformity at: www.festo.com/sp → User documentation.
If the component is subject to restrictions on usage in residential, office or commercial environments or small businesses, further measures to reduce the emitted interference may be necessary.

Performance data – High vacuum																				
Type	OVEM-05				OVEM-07				OVEM-10				OVEM-14				OVEM-20			
Normal position of the vacuum generator	ON	OE	CN	CE	ON	OE	CN	CE	ON	OE	CN	CE	ON	OE	CN	CE	ON	OE	CN	CE
Max. vacuum [%]	93																			
Operating pressure for max. vacuum [bar]	5.1				4.1				3.5				3.6				5.3			
Max. suction rate with respect to atmosphere [l/min]	6				16				19.5				50.5				86.5			
Suction rate at p ₁ = 6 bar [l/min]	5.9				15.1				18.6				46				80.5			
Air supply time ¹⁾ for 1 l volume, at p ₁ = 6 bar [s]	4.8	2	4.8	2	1.9	0.4	1.9	0.4	1.2	0.2	1.2	0.2	0.6	0.2	0.6	0.2	0.4	0.2	0.4	0.2
Noise level at p ₁ = 6 bar [db(A)]	51				58				73				77				74			

- Duration for vacuum purging down to a residual vacuum of -005 bar after switching off the operating pressure.

Performance data – High suction rate																
Type	OVEM-05				OVEM-07				OVEM-10				OVEM-14			
Normal position of the vacuum generator	ON	OE	CN	CE	ON	OE	CN	CE	ON	OE	CN	CE	ON	OE	CN	CE
Max. suction rate with respect to atmosphere [l/min]	13				31.5				45				92			
Suction rate at p ₁ = 6 bar [l/min]	12.8				31.5				45.1				88.7			
Air supply time ¹⁾ for 1 l volume, at p ₁ = 6 bar [s]	2	1.3	2	1.3	1	0.2	1	0.2	0.8	0.2	0.8	0.2	0.4	0.2	0.4	0.2
Noise level at p ₁ = 6 bar [db(A)]	45				53				64				70			

- Duration for vacuum purging down to a residual vacuum of -005 bar after switching off the operating pressure.

Vacuum generators OVEM

Technical data

FESTO

Technical data – Electrical data, general							
Type		Without vacuum sensor		With vacuum sensor			
				OVEM-...-1P/1N	OVEM-...-1PD	OVEM-...-2P/2N	OVEM-...-PU/PI
Electrical connection		Plug connector M12x1, 5-pin					
Standard switching input		IEC 61131-2					
Operating voltage range	[V DC]	20.4 ... 27.6					
Duty cycle	[%]	100					
Coil characteristics 24 V DC	[W]	Low-current phase: 0.3 High-current phase: 2.55					
Max. current consumption	[mA]	30	180	170	270	180	150 (270 in SIO mode)
Insulation voltage	[V]	50					
Surge resistance	[kV]	0.8					
Degree of contamination		3					
Protection against incorrect polarity		For all electrical connections					
Switching position indication		LED		LCD			

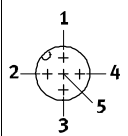
Pin allocation			
Plug connector M12x1, 5-pin	Pin	Meaning	
		OVEM without vacuum sensor	
	1	Supply voltage +24 V DC	
	2	Switching input for vacuum ON/OFF	
	3	0 V	
	4	No function	
	5	Switching input for ejector pulse ON/OFF	
			OVEM-...-1P/1N
	1	Supply voltage +24 V DC	
	2	Switching input for vacuum ON/OFF	
	3	0 V	
	4	Switching output (switching output for vacuum sensor)	
	5	Switching input for ejector pulse ON/OFF	
			OVEM-...-1PD
	1	Supply voltage +24 V DC	
	2	Digital output Out A (switching output for vacuum sensor)	
	3	0 V	
	4	Digital switching input (ejector pulse)	
	5	Digital switching input (vacuum ON/OFF)	
			OVEM-...-2P/2N/PU/PI
	1	Supply voltage +24 V DC	
	2	Digital output Out B (OVEM-...-2P/2N) Analogue output Out B (OVEM-...-PU/PI)	
	3	0 V	
	4	Digital output Out A (switching output for vacuum sensor)	
	5	Digital switching input (vacuum ON/OFF and ejector pulse)	
			OVEM-...-LK
1	Supply voltage +24 V DC		
2	Digital output Out B		
3	0 V		
4	IO-Link communication or digital output Out A (switching output for vacuum sensor) ¹⁾		
5	Not assigned, or digital switching input (vacuum ON/OFF and ejector pulse) ²⁾		

1) After a fallback or in SIO mode, this pin has the configuration of a digital switching output.

2) This pin is not assigned in IO-Link mode. After a fallback or in SIO mode, this pin has the configuration of a digital input.

Vacuum generators OVEM

Technical data

Technical data – Vacuum sensor								
Vacuum sensor	1PD	2P	2N	PU	PI	LK	1P	1N
Input signal/measuring element								
Measured variable	Relative pressure							
Measuring principle	Piezoresistive							
Pressure measuring range	[bar]	-1 ... 0						
Display/operation								
Setting options	Via display and keys					IO-Link	Teach-in	
Threshold value setting range	[bar]	-0.999 ... 0					-1 ... 0	
Hysteresis setting range	[bar]	-0.9 ... 0					-	
Setting range duration, ejector pulse	[ms]	- ¹⁾	20 ... 9999 (OVEM-05)			40 ... 9999	-	
			40 ... 9999 (OVEM-07/10/14/20)					
Display type	4-character alphanumeric, backlit LCD						LED	
Displayable units	-	bar					-	
	H	inchHg					-	-
Indicating range	[bar]	-0.999 ... 0					-	
	[inchHg]	-29.5 ... 0					-	-
Protection against tampering	PIN code	-				Electronic locking	-	
Accuracy								
Accuracy FS ²⁾	[%]	±3					±0.5	
Reproducibility switching value FS ²⁾	[%]	0.6					0.6	
Inputs/outputs								
Switching logic at inputs	PNP	PNP	NPN	PNP	PNP	PNP	PNP	NPN
Switching output	1x PNP	2x PNP	2x NPN	1x PNP	1x PNP	2x PNP	1x PNP	1x NPN
Switching function	Window comparator						-	
	Threshold value comparator ³⁾							
Switching status indication	Opto-electrical							
Switching element function	N/O contact							
	N/C contact						-	
Fixed hysteresis	[mbar]	-					20	
Max. output current	[mA]	100						
Idle current	[mA]	< 70					< 80	
Residual current	[mA]	0.1						
Voltage drop	[V]	≤ 2	≤ 1.5			≤ 1.8	≤ 1.5	
Analogue output	[V]	-	-		0 ... 10	-	-	
	[mA]	-	-		-	4 ... 20	-	
Permitted load resistance analogue output	[ohms]	-			Min. 2000	Max. 500	-	
Accuracy of analogue output FS ²⁾	[%]	-			4	-	-	
Short circuit protection	Yes							
Inductive protective circuit	Adapted to MZ, MY, ME coils					-	Adapted to MZ, MY, ME coils	
Overload protection	Yes							

1) Generation of an ejector pulse via a control signal at the digital switching input

2) % FS = % of measuring range final value (full scale)

3) OVEM-...-1P/1N threshold value with fixed hysteresis

Vacuum generators OVEM

Technical data

FESTO

Technical data – IO-Link				
Type	OVEM-...-H-...-OE-N-LK	OVEM-...-L-...-OE-N-LK	OVEM-...-H-...-CE-N-LK	OVEM-...-L-...-CE-N-LK
Protocol version	Device V 1.1			
Profile	Smart sensor profile			
Function classes	Binary data channel (BDC)			
	Diagnostics			
	Identification			
	Process data variable (PDV)			
	Teach channel			
Communication mode	COM2 (38.4 kBaud)			
Port class	A			
Process data width OUT	1 bytes			
Process data content OUT	1 bit (ejector pulse ON/OFF)			
	1 bit (vacuum ON/OFF)			
Process data width IN	Parameterisable 8 or 16 bytes			
Process data content IN	14 bit PDV (pressure reading)			
	2 bit BDC (pressure monitoring)			
Minimum cycle time [ms]	3.5			
Data memory required	0.5 KB			
Device ID	0x00003C	0x00003D	0x00003E	0x00003F

Materials

Sectional view

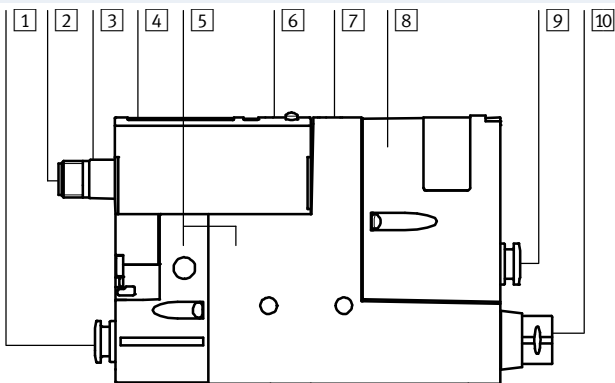

OVEM		1PD/2P/2N/PU/ PI/LK	1P/1N
1	Fitting	QS/QO	Nickel-plated brass
	Connecting thread	GN/GO	Anodised wrought aluminium alloy
2	Pin contacts		Gold-plated brass
3	Plug housing		Nickel-plated brass
4	Inspection window		PA
5	Housing		Die-cast aluminium, reinforced PA
6	Key pad		TPE-U
7	Regulating screw	CE/OE	Steel
8	Filter housing		Reinforced PA
9	Fitting	QS/QO/ PL/PO	Nickel-plated brass
	Connecting thread	GN/GO	Anodised wrought aluminium alloy
10	Silencer	QO/GO/ PO	Wrought aluminium alloy, PU foam
	Fitting	QS/QO/ PL/PO	Nickel-plated brass
		GN/GO	Anodised wrought aluminium alloy
–	Screws		Steel
–	Pins		Steel
–	Jet nozzle		Wrought aluminium alloy
–	Collector nozzle		POM
–	Filter		Fabric, PA, sintered steel
–	Seals		NBR
–	Hollow bolt	PL/PO	Wrought aluminium alloy
–	Mounting bracket	PL/PO	Stainless steel
Note on materials			RoHS compliant
		QO/GO/ PO	Contains paint-wetting impairment substances

Vacuum generators OVEM

Technical data

Vacuum p_u as a function of operating pressure p_1

High vacuum

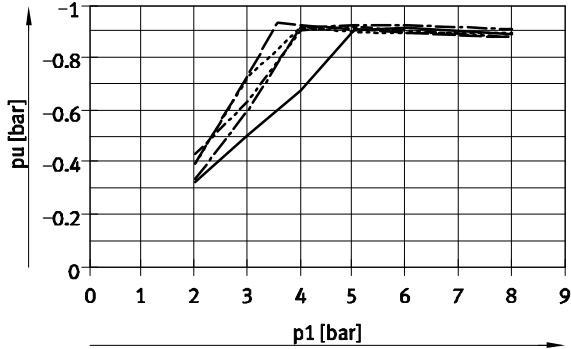

- OVEM-05-H
- - - OVEM-07-H
- · - OVEM-10-H
- · · OVEM-14-H
- · - OVEM-20-H

High suction rate

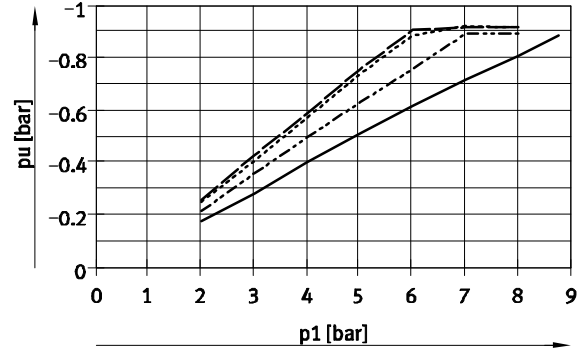

- OVEM-05-L
- - - OVEM-07-L
- · - OVEM-10-L
- · · OVEM-14-L
- · - OVEM-20-L

Evacuation time t as a function of vacuum p_u for 1 l volume at 6 bar operating pressure

High vacuum

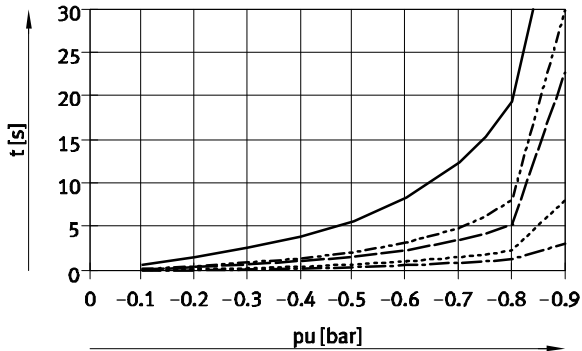

- OVEM-05-H
- - - OVEM-07-H
- · - OVEM-10-H
- · · OVEM-14-H
- · - OVEM-20-H

High suction rate

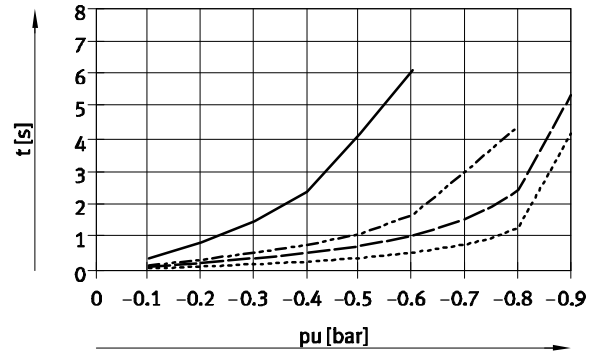

- OVEM-05-L
- - - OVEM-07-L
- · - OVEM-10-L
- · · OVEM-14-L
- · - OVEM-20-L

Air consumption q_n as a function of operating pressure p_1

High vacuum/high suction rate

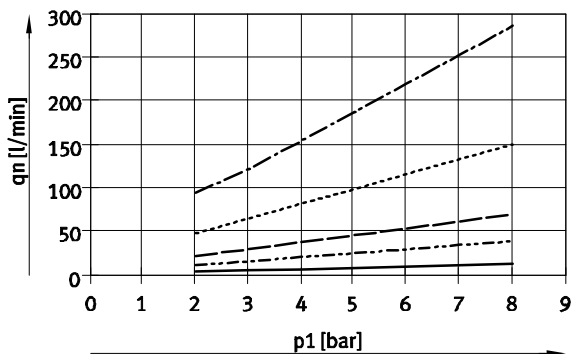

- OVEM-05
- - - OVEM-07
- · - OVEM-10
- · · OVEM-14
- · - OVEM-20

Vacuum generators OVEM

Technical data

FESTO

Dimensions

Download CAD data → www.festo.com

OVEM-05

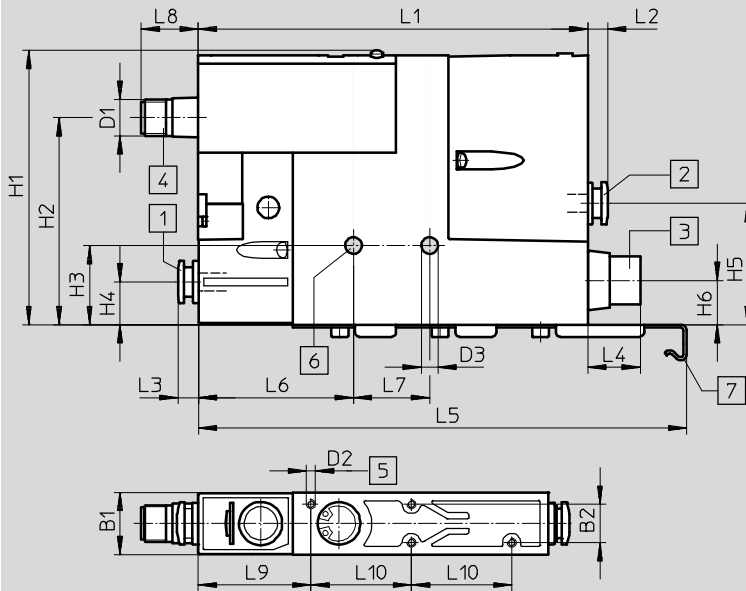

- 1 Supply port (P)
- 2 Vacuum port (V)
- 3 Exhaust port (R)
- 4 Electrical connection to fit NEBU-M12G5-K-...
- 5 Mounting thread M3
Max. tightening torque 0.8 Nm
- 6 Mounting hole
Max. tightening torque 2.5 Nm
- 7 Mounting bracket only provided for OVEM-...-PL/PO

Type	Pneumatic connections			D1	D2	D3	B1	B2	H1	H2	H3	H4
	P	V	R									
OVEM-05-...-QS-...	QS-6	QS-6	QS-8	M12x1	M3	5.5	20.5	12.6	90	68	26	14.5
OVEM-05-...-QO-...			SD ²⁾									
OVEM-05-...-PL-...	(G1/4) ¹⁾	QS-6	QS-8									
OVEM-05-...-PO-...			SD ²⁾									
OVEM-05-...-GN-...	G1/8	G1/8	G1/8									
OVEM-05-...-GO-...			SD ²⁾									

Type	H5	H6	L1	L2	L3	L4	L5	L6	L7	L8	L9	L10
OVEM-05-...-QS-...	40	14.5	115	6.5	6.5	12	-	51	25	18	37	33
OVEM-05-...-QO-...						-						
OVEM-05-...-PL-...						12						
OVEM-05-...-PO-...				-	160.5							
OVEM-05-...-GN-...				8.2								
OVEM-05-...-GO-...				-								

- 1) Thread for mounting on the common supply manifold → 19
- 2) SD = Silencer

Minimum inside diameter [mm] of the connection tubes for connections with G-female thread

Type	OVEM-05-...-GN/GO	
Tubing length	< 0.5 m	< 2 m
Pneumatic connection 1 (P)	1	2
Vacuum port (V)	2	3
Pneumatic connection 3 (R)	2	3

Vacuum generators OVEM

Technical data

FESTO

Dimensions

Download CAD data → www.festo.com

OVEM-07/10

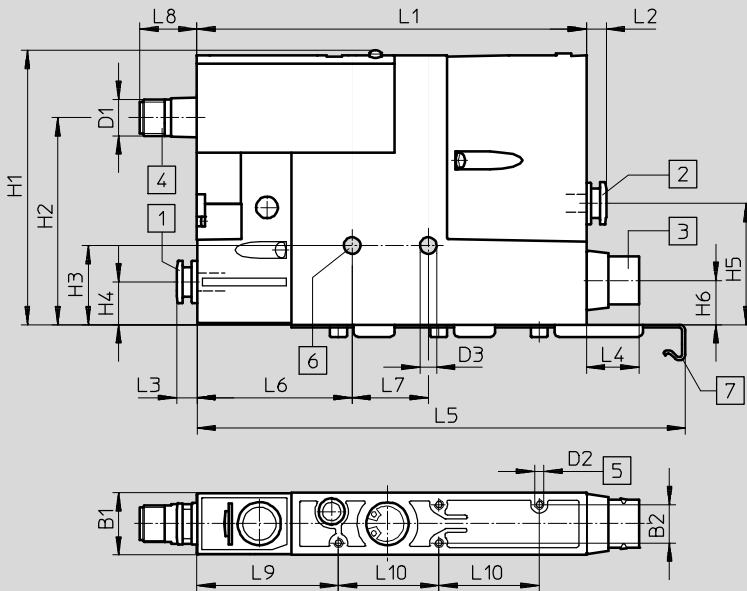

- 1 Supply port (P)
- 2 Vacuum port (V)
- 3 Exhaust port (R)
- 4 Electrical connection to fit NEBU-M12G5-K-...
- 5 Mounting thread M3
Max. tightening torque 0.8 Nm
- 6 Mounting hole
Max. tightening torque 2.5 Nm
- 7 Mounting bracket only provided for OVEM-...-PL/PO

Type	Pneumatic connections			D1	D2	D3	B1	B2	H1	H2	H3	H4
	P	V	R									
OVEM-07/10-...-QS-...	QS-8	QS-8	QS-8	M12x1	M3	5.5	20.5	12.6	90	68	26	14.5
OVEM-07/10-...-QO-...			SD ²⁾									
OVEM-07/10-...-PL-...	(G1/4) ¹⁾	QS-8	QS-8									
OVEM-07/10-...-PO-...			SD ²⁾									
OVEM-07/10-...-GN-...	G1/4	G1/4	G3/8									
OVEM-07/10-...-GO-...			SD ²⁾									

Type	H5	H6	L1	L2	L3	L4	L5	L6	L7	L8	L9	L10	
OVEM-07/10-...-QS-...	40	14.5	128	6.5	6.5	12	-	51	25	18	46.5	33	
OVEM-07/10-...-QO-...						17.3							
OVEM-07/10-...-PL-...					12	160.5							
OVEM-07/10-...-PO-...					17.3								
OVEM-07/10-...-GN-...					17.2	17.2	-						-
OVEM-07/10-...-GO-...							17.3						

- 1) Thread for mounting on the common supply manifold → 19
- 2) SD = Silencer

Minimum inside diameter [mm] of the connection tubes for connections with G-female thread				
Type	OVEM-07-...-GN/GO		OVEM-10-...-GN/GO	
Tubing length	< 0.5 m	< 2 m	< 0.5 m	< 2 m
Pneumatic connection 1 (P)	1.5	2	2	3
Vacuum port (V)	3	4	4	5
Pneumatic connection 3 (R)	3	4	4	5

Vacuum generators OVEM

Technical data

FESTO

Dimensions

Download CAD data → www.festo.com

OVEM-14/20

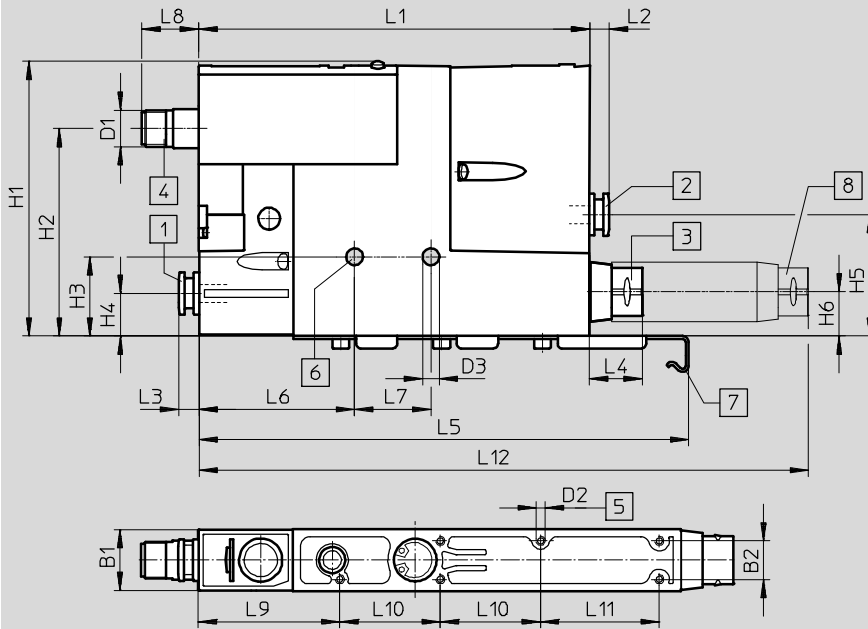

- 1 Supply port (P)
- 2 Vacuum port (V)
- 3 Exhaust port (R)
- 4 Electrical connection to fit NEBU-M12G5-K-...
- 5 Mounting thread M3
Max. tightening torque 0.8 Nm
- 6 Mounting hole
Max. tightening torque 2.5 Nm
- 7 Mounting bracket only provided for OVEM-...-PL/PO
- 8 Silencer extension (included in the scope of delivery for OVEM-20)

Type	Pneumatic connections			D1	D2	D3	B1	B2	H1	H2	H3	H4
	P	V	R									
OVEM-14/20-...-QS-...	QS-8	QS-8	QS-8	M12x1	M3	4.3	20.5	12.6	90	68	25	14.5
OVEM-14/20-...-QO-...			SD ²⁾									
OVEM-14/20-...-PL-...	(G1/4) ¹⁾	QS-8	QS-8									
OVEM-14/20-...-PO-...			SD ²⁾									
OVEM-14/20-...-GN-...	G1/4	G1/4	G3/8									
OVEM-14/20-...-GO-...			SD ²⁾									

Type	H5	H6	L1	L2	L3	L4	L5	L6	L7	L8	L9	L10	L11	L12	
OVEM-14/20-...-QS-...	40	14.5	158	6.5	6.5	12	160.5	57	25	18	46.5	33	39	-	
OVEM-14/20-...-QO-...						17.3								-	~230
OVEM-14/20-...-PL-...						12								-	-
OVEM-14/20-...-PO-...				17.3	-	~230									
OVEM-14/20-...-GN-...				17.2	17.2	17.2	-							-	-
OVEM-14/20-...-GO-...							17.3							-	~230

- 1) Thread for mounting on the common supply manifold → 19
- 2) SD = Silencer

Minimum inside diameter [mm] of the connection tubes for connections with G-female thread

Type	OVEM-14-...-GN/GO		OVEM-20-...-GN/GO	
	< 0.5 m	< 2 m	< 0.5 m	< 2 m
Pneumatic connection 1 (P)	3	4	4	5
Vacuum port (V)	5.5	6	6	7
Pneumatic connection 3 (R)	5.5	6	6	7

Vacuum generators OVEM

Technical data

FESTO

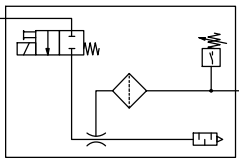
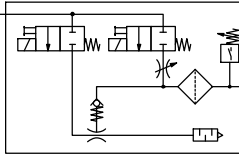
Ordering data and weight											
Circuit symbol	Description	Electrical switching output	Display	Nominal width of laval nozzle [mm]	Weight [g]	Part No.	Type				
NC – normally closed											
	P-V with QS fitting, R with open silencer	2x PNP	LCD	0.45	320	538834	OVEM-05-H-B-QO-CN-N-2P				
				0.7	325	538835	OVEM-07-H-B-QO-CN-N-2P				
				0.95		538836	OVEM-10-H-B-QO-CN-N-2P				
				1.4	370	539998	OVEM-14-H-B-QO-CN-N-2P				
	With ejector pulse, P-V with QS fitting, R with open silencer	2x PNP	LCD	0.45	325	538831	OVEM-05-H-B-QO-CE-N-2P				
				0.7	330	538832	OVEM-07-H-B-QO-CE-N-2P				
				0.95		538833	OVEM-10-H-B-QO-CE-N-2P				
				1.4	380	539997	OVEM-14-H-B-QO-CE-N-2P				
				2.0		8023700	OVEM-20-H-B-QO-CE-N-2P				
				2x NPN	LCD	0.7	330	540018	OVEM-07-H-B-QO-CE-N-2N		
						0.95		540019	OVEM-10-H-B-QO-CE-N-2N		
						1.4	380	540020	OVEM-14-H-B-QO-CE-N-2N		
						PNP	LED	0.45	315	540021	OVEM-05-H-B-QO-CE-N-1P
								0.7	320	540022	OVEM-07-H-B-QO-CE-N-1P
								0.95		540023	OVEM-10-H-B-QO-CE-N-1P
				PNP	LCD	1.4	371	540024	OVEM-14-H-B-QO-CE-N-1P		
		2.0				8023699	OVEM-20-H-B-QO-CE-N-1P				
		0.45	325			8037697	OVEM-05-H-B-QO-CE-N-1PD				
		0.7	330			8037698	OVEM-07-H-B-QO-CE-N-1PD				
		0.95				8037699	OVEM-10-H-B-QO-CE-N-1PD				
		IO-Link, 2x PNP in SIO mode	LCD	1.4	380	8037700	OVEM-14-H-B-QO-CE-N-1PD				
				0.45	325	8037693	OVEM-05-H-B-QO-CE-N-LK				
				0.7	330	8037694	OVEM-07-H-B-QO-CE-N-LK				
				0.95		8037695	OVEM-10-H-B-QO-CE-N-LK				
		With ejector pulse, P-V with female thread, R with open silencer	2x PNP	LCD	0.7	335	540015	OVEM-07-H-B-GO-CE-N-2P			
					0.95		540016	OVEM-10-H-B-GO-CE-N-2P			
					1.4	385	540017	OVEM-14-H-B-GO-CE-N-2P			
					2x NPN	LCD	0.7	335	540012	OVEM-07-H-B-GO-CE-N-2N	
							0.95		540013	OVEM-10-H-B-GO-CE-N-2N	
							1.4	385	540014	OVEM-14-H-B-GO-CE-N-2N	
			PNP	LED	0.45	300	540025	OVEM-05-H-B-GO-CE-N-1P			
					0.7	325	540026	OVEM-07-H-B-GO-CE-N-1P			
0.95					540027	OVEM-10-H-B-GO-CE-N-1P					
With ejector pulse, prepared for common supply manifold, V with QS fitting, R with open silencer	2x PNP		LCD	2.0	410	8023702	OVEM-20-H-B-PO-CE-N-2P				
	PNP		LED	2.0	400	8023701	OVEM-20-H-B-PO-CE-N-1P				

Vacuum generators OVEM

Technical data

FESTO

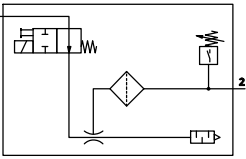
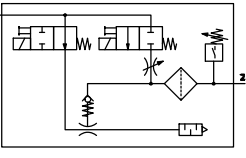
Ordering data and weight										
Circuit symbol	Description	Electrical switching output	Display	Nominal width of laval nozzle [mm]	Weight [g]	Part No.	Type			
NO – normally open										
	P-V with QS fitting, R with open silencer	2x PNP	LCD	0.45	320	538828	OVEM-05-H-B-QO-ON-N-2P			
				0.7	325	538829	OVEM-07-H-B-QO-ON-N-2P			
				0.95		538830	OVEM-10-H-B-QO-ON-N-2P			
				1.4	370	539996	OVEM-14-H-B-QO-ON-N-2P			
	With ejector pulse, P-V with QS fitting, R with open silencer	2x PNP	LCD	0.45	325	538825	OVEM-05-H-B-QO-OE-N-2P			
				0.7	330	538826	OVEM-07-H-B-QO-OE-N-2P			
				0.95		538827	OVEM-10-H-B-QO-OE-N-2P			
				1.4	380	539995	OVEM-14-H-B-QO-OE-N-2P			
				With ejector pulse, P-V with female thread, R with open silencer	2x NPN	LCD	0.7	330	540009	OVEM-07-H-B-QO-OE-N-2N
							0.95		540010	OVEM-10-H-B-QO-OE-N-2N
	1.4	380	540011				OVEM-14-H-B-QO-OE-N-2N			
	With ejector pulse, P-V with female thread, R with open silencer	2x PNP	LCD				0.7	335	540006	OVEM-07-H-B-GO-OE-N-2P
				0.95		540007	OVEM-10-H-B-GO-OE-N-2P			
				1.4	385	540008	OVEM-14-H-B-GO-OE-N-2P			
With ejector pulse, P-V with female thread, R with open silencer				2x NPN	LCD	0.7	335	540003	OVEM-07-H-B-GO-OE-N-2N	
	0.95		540004			OVEM-10-H-B-GO-OE-N-2N				
	1.4	385	540005			OVEM-14-H-B-GO-OE-N-2N				

Vacuum generators OVEM

Ordering data – Modular product system

FESTO

Ordering table				
Size	20	Condi- tions	Code	Entry code
M Module no.	539074			
Vacuum generators	Vacuum generator with solenoid valve for vacuum valve on/off and manual override		OVEM	OVEM
Nominal width of laval nozzle [mm]	0.45		-05	
	0.7		-07	
	0.95		-10	
	1.4		-14	
	2.0		-20	
Ejector characteristic	High vacuum		-H	
	High suction rate	1	-L	
Housing size/width [mm]	20		-B	-B
Pneumatic connections	All connections with QS fittings		-QS	
	Supply/vacuum port with QS fittings, exhaust port with open silencer		-QO	
	All ports with G female thread		-GN	
	Supply / vacuum port with G female thread, exhaust port with open silencer		-GO	
	Prepared for supply manifold, vacuum port and exhaust port with QS fittings		-PL	
	Prepared for supply manifold, vacuum port with QS fittings, exhaust port with open silencer		-PO	
Normal position of the vacuum generator	NO, normally open (vacuum generation)		-ON	
	NO, normally open (vacuum generation) with ejector pulse		-OE	
	NC, normally closed (no vacuum generation)		-CN	
	NC, normally closed (no vacuum generation) with ejector pulse		-CE	
Electrical connection	Plug M12 (5-pin)		-N	-N
O Vacuum sensor, (standard scale in bar)	Without vacuum sensor			
	1 switching output PNP		-1P	
	1 switching output PNP and LCD display	2	-1PD	
	1 switching output NPN	1	-1N	
	2 switching outputs PNP		-2P	
	1 switching output PNP, 1 analogue output 0 ... 10 V		-PU	
	1 switching output PNP, 1 analogue output 4 ... 20 mA		-PI	
	2 switching outputs NPN		-2N	
	IO-Link	2	-LK	
Alternative vacuum display	InchHg	1	-H	

1 **L, 1N, H** Not with laval nozzle of nominal size 2.0 mm.

2 **1PD, LK** Not with normal position of the vacuum generator ON and CN.

M Mandatory data

O Options

Transfer order code

539074 OVEM - [] - [] - B - [] - [] - N - [] - []

Vacuum generators OVEM

Accessories

FESTO

Common supply manifold OABM-P

For vacuum generator
OVEM-...-PL/PO

Pneumatic connection 1: G3/4
Type of mounting: with through-hole

Materials: Wrought aluminium alloy

Note on materials:
RoHS compliant

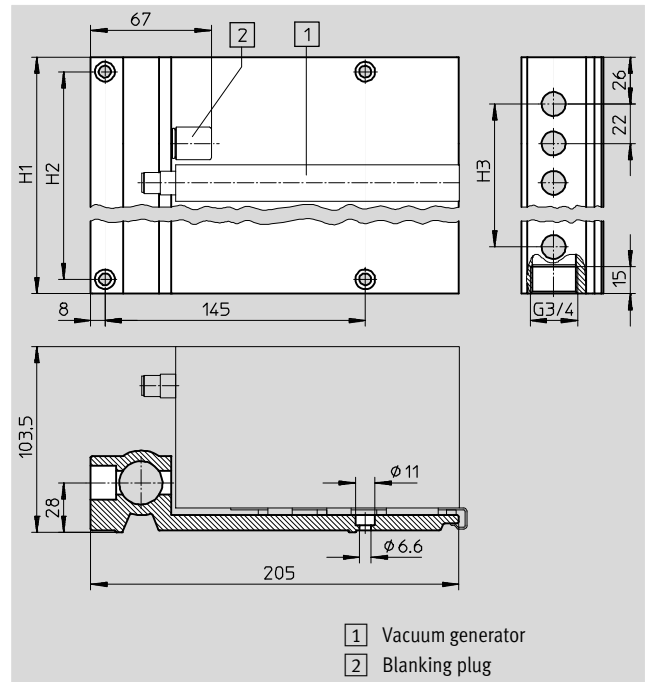
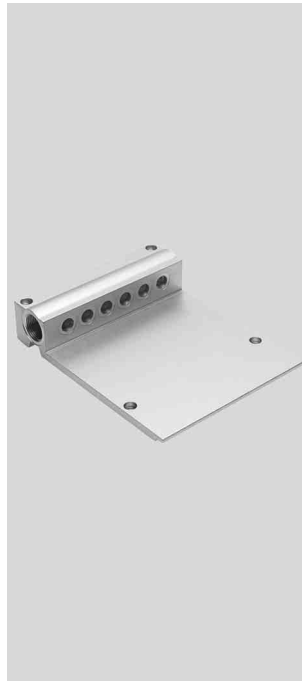

Dimensions			
Number of device locations	H1	H2	H3
4	118	102	66
6	162	146	110
8	206	190	154

Tubing I.D. d_i as a function of total air consumption q_{nN}																	
Total air consumption [l/min]																	
50	75	154	175	225	310	400	480	500	750	890	1000	1190	1340	1850	2240	2300	2900
Tubing I.D. ¹⁾ [mm]																	
≥ 2.5	≥ 2.9	≥ 3.8	≥ 4	≥ 4.4	≥ 5	≥ 5.5	≥ 5.9	≥ 6	≥ 7	≥ 7.5	≥ 8	≥ 8.4	≥ 8.8	≥ 10	≥ 10.8	≥ 11	≥ 12
Recommended tubing																Technical data → Internet: pun, pan	
PUN-4	PUN-6	PUN-8		PUN-10			PUN-12		PUN-16			PAN-16					

1) With a tubing length of 3 m

Note

The total air consumption of the fully equipped common supply manifold of vacuum generators with ejector pulse (OE, CE), the individually set values for the ejector pulse (duration and intensity) can result in much higher air consumption.

Ordering data and weight					
	No. of device locations	CRC ¹⁾	Weight [g]	Part No.	Type
Common supply	4	2	767	549456	OABM-P-4
	6	2	1045	549457	OABM-P-6
	8	2	1330	549458	OABM-P-8

1) Corrosion resistance class CRC 2 to Festo standard FN 940070
Moderate corrosion stress. Indoor applications in which condensation may occur. External visible parts with primarily decorative requirements for the surface and which are in direct contact with the ambient atmosphere typical for industrial applications.

Vacuum generators OVEM

Accessories

FESTO

Blanking plug OASC-G1-P

For common supply OABM-P...

Type of mounting: threaded

Max. tightening torque: 10 Nm

Material:

Hollow bolt: Wrought aluminium alloy

Blanking cap: Steel

Seals: Steel, nitrile rubber

Note on materials:

RoHS compliant



Ordering data				
	CRC ¹⁾	Weight [g]	Part No.	Type
Blanking plug	2	53	549460	OASC-G1-P

1) Corrosion resistance class CRC 2 to Festo standard FN 940070

Moderate corrosion stress. Indoor applications in which condensation may occur. External visible parts with primarily decorative requirements for the surface and which are in direct contact with the ambient atmosphere typical for industrial applications.

H-rail mounting

OABM-H

For vacuum generator OVEM

Max. tightening torque for H-rail mounting: 0.8 Nm

Material: Galvanised steel

Note on materials:

RoHS compliant

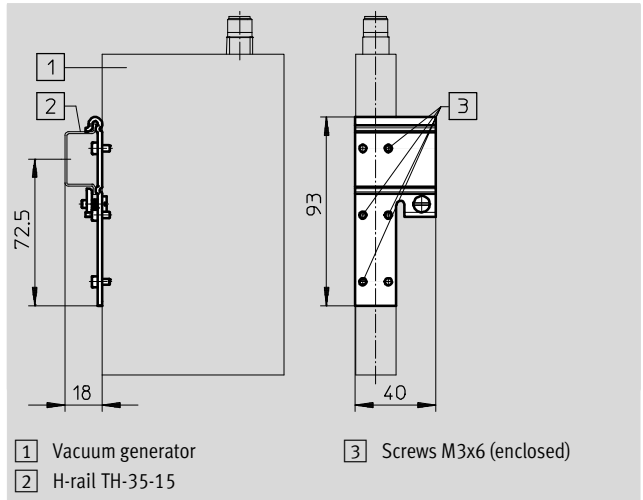



Ordering data				
		Weight [g]	Part No.	Type
H-rail mounting		52	549461	OABM-H

Vacuum generators OVEM

Accessories

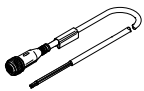
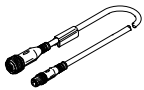
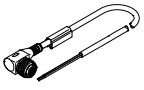
FESTO

Ordering data – Connecting cable NEBU-M12				Technical data → Internet: nebu	
	Electrical connection		Cable length [m]	Part No.	Type
	Straight socket, M12x1, 5-pin	Open end, 5-wire	2.5	541330	NEBU-M12G5-K-2.5-LE5
			5	541331	NEBU-M12G5-K-5-LE5
			10	554038	NEBU-M12G5-K-10-LE5
	Straight socket, M12x1, 5-pin	Straight plug, M8x1, 4-pin, rotatable thread	2.5	554036	NEBU-M12G5-K-2.5-M8G4
	Angled socket, M12x1, 5-pin	Open end, 5-wire	2.5	567843	NEBU-M12W5-K-2.5-LE5
			5	567844	NEBU-M12W5-K-5-LE5

Ordering data – Silencer extension UOMS				Technical data → Internet: uoms	
	Design	Type of mounting	Part No.	Type	
	Open silencer	Engaging	538436	UOMS-1/4	

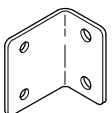
Ordering data – Mounting bracket HRM				Technical data → Internet: hrm	
	Material		Part No.	Type	
	Galvanised steel		9769	HRM-1	

Festo - Your Partner in Automation



1 Festo Inc.
5300 Explorer Drive
Mississauga, ON L4W 5G4
Canada

Festo Customer Interaction Center
Tel: 1 877 463 3786
Fax: 1 877 393 3786
Email: customer.service.ca@festo.com



2 Festo Pneumatic
Av. Ceylán 3,
Col. Tequesquináhuac
54020 Tlalneantla,
Estado de México

Multinational Contact Center
01 800 337 8669
ventas.mexico@festo.com



3 Festo Corporation
1377 Motor Parkway
Suite 310
Islandia, NY 11749

Festo Customer Interaction Center
1 800 993 3786
1 800 963 3786
customer.service.us@festo.com



4 Regional Service Center
7777 Columbia Road
Mason, OH 45040

Connect with us



www.festo.com/socialmedia



www.festo.com

Subject to change